

## MAIN FEATURES

- Wide input voltage range: 120 – 277 V<sub>AC</sub>
- Constant current output
- IEEE 1789 Compliant (tested from 50% to 100% I<sub>max</sub>)
- Low dimming level (down to 1 % of max current)
- IP 64 package
- Low standby power consumption (<0.5 W)
- High efficiency (up to 88 %)
- Easily programmable via RFID (wireless) or wired tools
- Programmable output current settings
- Dimmable with 1-10V / 0-10V dimmers. Dim to OFF (DTO)
- Temperature sensor input (NTC) to protect the LED light engine
- Intended for convection cooling operation
- UL Class 2 output, reinforced / double isolation
- Wide operating temperature range -30 C up to 90 °C T<sub>c</sub>
- 8-year warranty under useful life condition

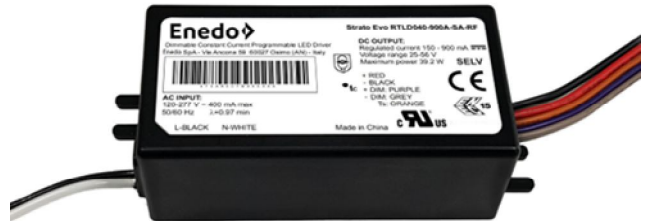

## DESCRIPTION

STRATO EVO 40W switch mode driver technology is designed to generate one constant current output from an AC wide input voltage range. The size and performance of these products make them the ideal choice for LED lighting applications.

## APPLICATIONS AND BENEFITS

STRATO EVO 40W is designed for directly powering LEDs in commercial and industrial lighting applications.

The product's extremely **small form factor** and **high efficiency** makes it suitable for integration into most light fixtures and standard electrical junction boxes.

A host of integrated **control features**:

- Simplify Light Fixture Design
- Ease Safety Approval Cycles
- Lower Fixture Complexity and Cost

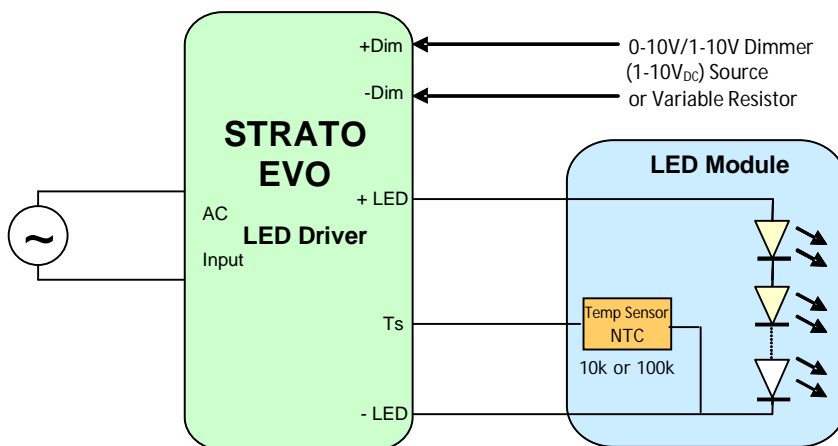

### STRATO EVO's versatile control features:

- A Temperature sensor (NTC thermistor) protects the LED from over-temperature. The NTC can be either a 10 kΩ or 100 kΩ
- A 2 wire Dimming input provides both output trimming, and 1 to 100 % I<sub>OUT</sub> Dimming function.

## MODEL CODING AND OUTPUT RATINGS

Model number	Case	Dimming	RFID Programming	P <sub>OUT</sub> Max (W)	V <sub>OUT</sub> Min (V <sub>DC</sub> )	V <sub>OUT</sub> Max (V <sub>DC</sub> )	I <sub>OUT</sub> Programmable range (mA)
RTLD040-900A-SA-RF	S Case	0-10 V	Yes	39.2	25	56	150 - 900
RTLD040-1400A-SA-RF	S Case	0-10 V	Yes	39.2	20	43	200 - 1400

Table 1: Absolute Maximum Driver Ratings

## OUTPUT RATING GRAPHS

RTLD040-900A-SA

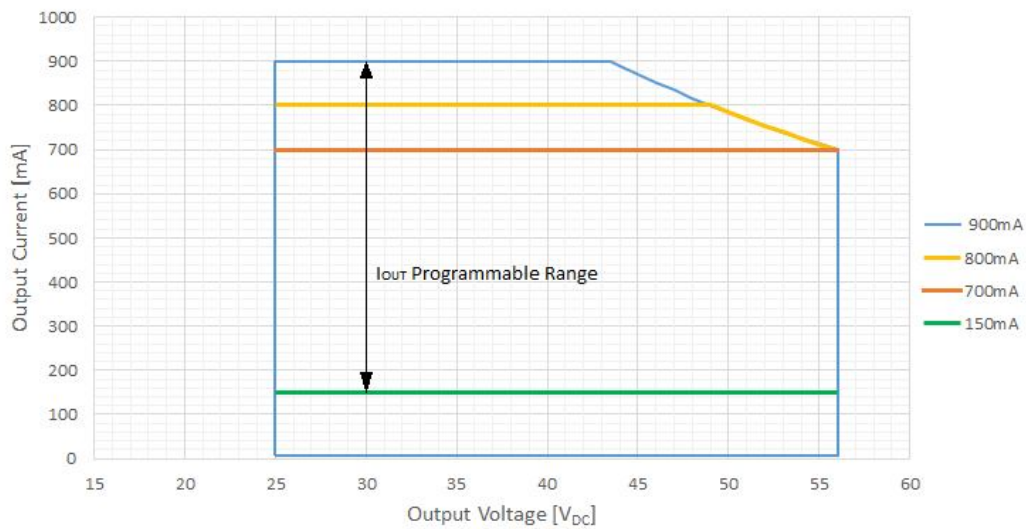

RTLD040-1400A-SA

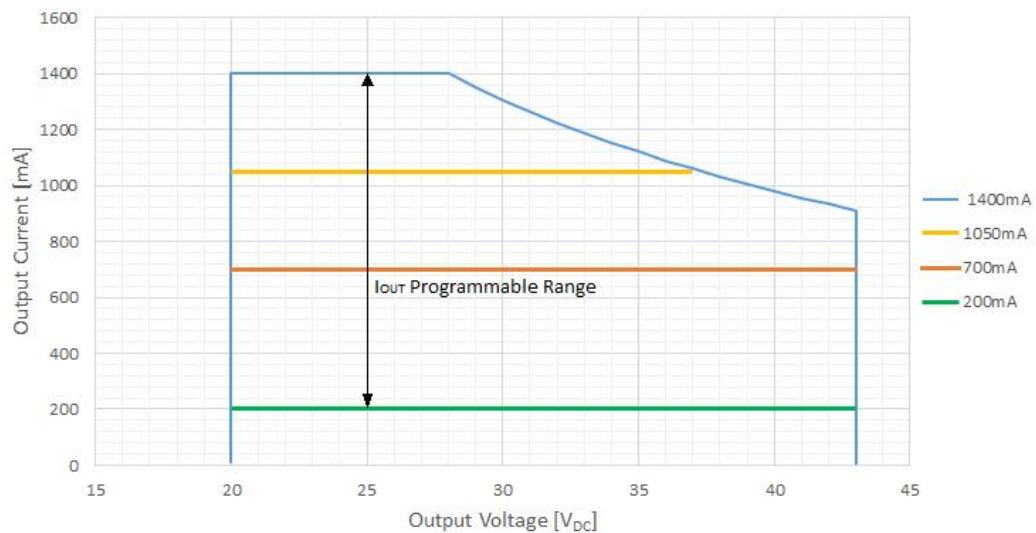

## INPUT SPECIFICATION

Specification	Test Conditions / Notes	Min	Nom	Max	Units
AC Input Voltage	Device starts and operates at 108 V <sub>AC</sub> at all load conditions	108	120 – 277	305	V <sub>AC</sub>
Input Frequency		47	50/60	63	Hz
Input Current	120 V <sub>AC</sub> Rated Load	-	-	0.39	A
	230 V <sub>AC</sub> Rated Load	-	-	0.20	
	277 V <sub>AC</sub> Rated Load	-	-	0.17	
Power Factor	120 V <sub>AC</sub> Rated Load (30-100 %)	0.9	0.99	-	
	230 V <sub>AC</sub> Rated Load (50-100 %)	0.9	0.98	-	
	277 V <sub>AC</sub> Rated Load (60-100 %)	0.9	0.97	-	
THD	120 V <sub>AC</sub> Rated Load (30-100 %)	-	9	20	%
	230 V <sub>AC</sub> Rated Load (50-100 %)	-	14	20	
	277 V <sub>AC</sub> Rated Load (60-100 %)	-	15	20	
Inrush Current (peak)	120 V <sub>AC</sub> Half Value time: 100 μs	-	-	15	A
	230 V <sub>AC</sub> Half Value time: 100 μs	-	-	35	
	277 V <sub>AC</sub> Half Value time: 100 μs	-	-	40	
Efficiency	120 V <sub>AC</sub> Rated Load	-	85.5	-	%
	230 V <sub>AC</sub> Rated Load	-	87	-	
	277 V <sub>AC</sub> Rated Load	-	87.5	-	
Harmonic Current	Complies with EN-61000-3-2, Class C load >25 W				

## OUTPUT SPECIFICATIONS

Specification	Test Conditions / Notes	Min	Nom	Max	Units
Output Power Rating		-	-	39.2	W
Output Voltage	900 model	25	-	56	V
	1400 model	20	-	43	
Output Current (programmable range)	900 model	150	-	900	mA
	1400 model	200	-	1400	
Minimum Dimming Level	900 model	3	6	9	mA
	1400 model	9	14	19	
Ripple Current_HF	High frequency (>40kHz) I <sub>OUTPK-pk</sub> /I <sub>OUTRMS</sub>	-	-	10	%
	900 model	-	-	30	
Ripple Current_LF	Low frequency [<1kHz] I <sub>OUTPK-pk</sub> /I <sub>OUTRMS</sub>	-	±1	-	%
Stand by Power		-	-	0.5	W
Output Regulation		-	±5	-	%I <sub>PROG</sub>
Start-up time	With no dimmer connected	-	300	500	ms

## PROTECTION FEATURES

Specification	Test Conditions / Notes	Min	Nom	Max	Units
Output Over Voltage	Unit latches Off after 4 attempts	110	-	130	%V <sub>MAX</sub>
Output Short-Circuit	Unit latches Off after 4 attempts <sup>1</sup>	-	-	-	-
Over-Temperature T <sub>c</sub>	When installed in an end-use application, care must be taken to ensure the driver case reference temperature, T <sub>c</sub> , below 90°C. Failing doing so, it will trigger output current reduction.		90		°C
No Load	Unit shuts down and latches off after 4 attempts				
Isolation Primary-to-Secondary	Reinforced/double Insulation meets IEC/EN61347-2-13				

<sup>1</sup> If the short-circuit is already present at power On, the units won't latch Off, and keep operating in hiccup mode.

## CONTROLS

**Output Controls:** Two dedicated inputs provide control and safety features.

**Dim:** A dimming input can be used to adjust the output setting via a standard commercial dimmer (0-10 V dimmer), an external control voltage source (0 to 10 V<sub>DC</sub>), or a variable resistor from 100 % to 1 % dimming. This permits active control of the driver dimming level.

**Is:** The Temperature input may be connected to a 100 kΩ or 10 kΩ NTC thermistor. The thermistor should be located on the LED assembly to monitor its temperature. If the temperature exceeds a predetermined set point, the module output current is automatically reduced to regulate the LED temperature at a safe level.

## INRUSH CURRENT DATA

Due to its limited Inrush Current peak at power on, STRATO EVO 40W LED driver makes easier the selection of overcurrent protection devices such as circuit breakers. Referring to the different kinds of circuit breakers available on the market, the maximum number of connectable Strato EVO 40W drivers is reported in the following table for each nominal input voltage, considering a circuit breaker load factor of 80 %.

Nominal Input (V <sub>AC</sub> )	Inrush Current Data		# Devices for each Circuit Breaker								
	I <sub>PEAK</sub> (A)	Half Value Time (μs)	Type B 10A	Type B 16A	Type B 20A	Type C 10A	Type C 16A	Type C 20A	Type D 10A	Type D 16A	Type D 20A
120	15	100	20	33	41	20	33	41	20	33	41
230	35	100	25	40	50	40	64	80	40	64	80
277	40	100	22	35	44	36	59	73	48	77	96

## STAND-BY POWER CONSUMPTION

Strato EVO 40W LED Driver offers a low stand-by power consumption when the LEDs are switched off using the 0-10 V dimmer option. The Analog driver, programmed with 0-10 V option, can switch Off the LEDs when the dimmer voltage is below 0.8 V. The typical stand-by power consumption is reported in the following table for each nominal input voltage.

V <sub>IN</sub> Nominal	Stand-by Power consumption (W)
120 V <sub>AC</sub>	0.22
230 V <sub>AC</sub>	0.35
277 V <sub>AC</sub>	0.43

## TEMPERATURE SENSE

The external temperature sense input (Ts) is used to connect the LED driver to an external NTC resistor, thermostat or circuit located near the LED to limit the maximum temperature of the LED assembly.

If no connection is made to the temperature sense input, the driver will operate at the nominal set point. The minimum output current value that can be reached by NTC limitation is approximately 20 % of I<sub>SET</sub>.

## TEMPERATURE SENSE - CHARACTERISTICS

By applying a variable resistance at the temperature sense input, the output current of the driver can be limited to help protect the LED against over temperature conditions. The Strato EVO 40W provide two different NTC curves characteristics: 10 kΩ and 100 kΩ.

The following graph shows the correlation between the resistance connected to the temperature sense input and the corresponding reduction in the output current of the driver.

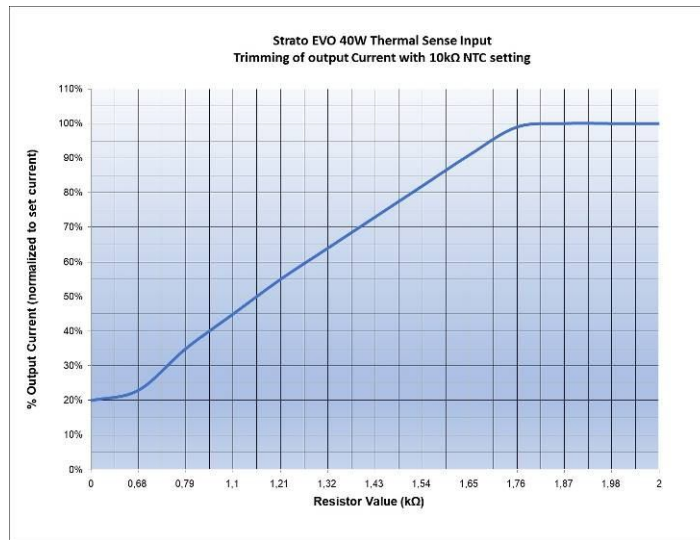

**10 KΩ NTC**

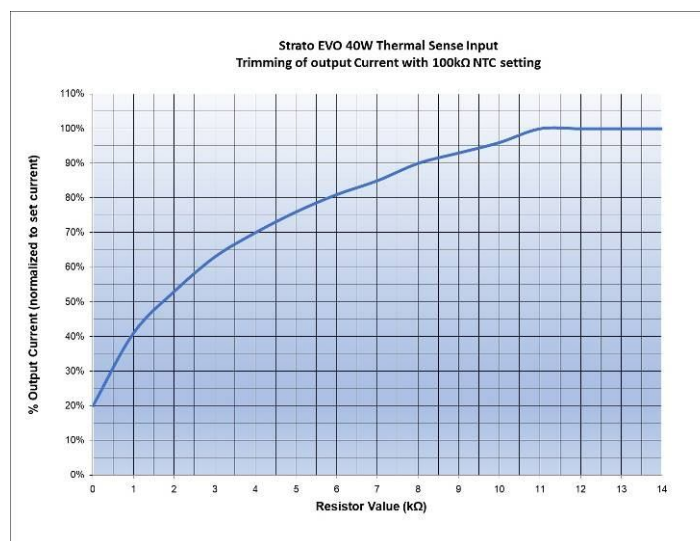

**100 KΩ NTC**

## LIFETIME VERSUS TOP CASE TEMPERATURE

The Strato EVO 40W has been designed to achieve 100Kh of Life Time when operating at 75-80 °C  $T_c$  (hot spot temperature on the case), at full load, nominal AC input voltages.

The following graphs are representative of the lifetime expectation for the Strato EVO 40W Led Driver Series. The curves have been evaluated in standard operative conditions.

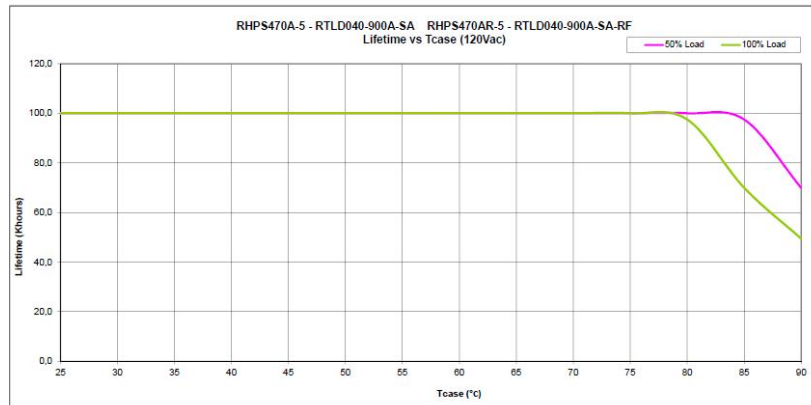

**RTLD040-0900A 120 V<sub>AC</sub> Full/Half load**

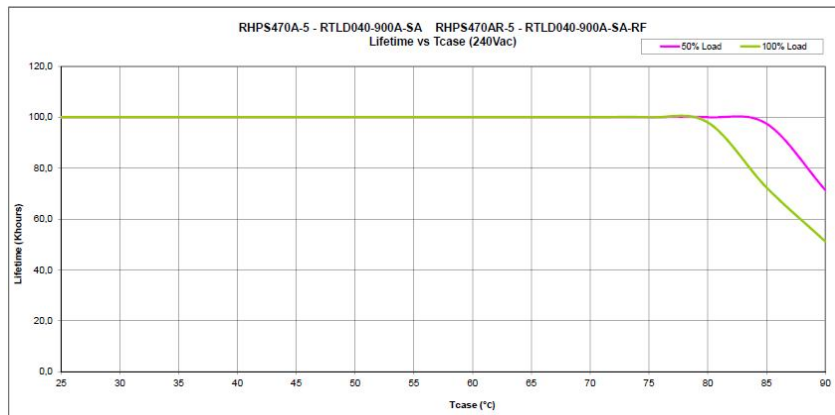

**RTLD040-0900A 230 V<sub>AC</sub> Full/Half load**

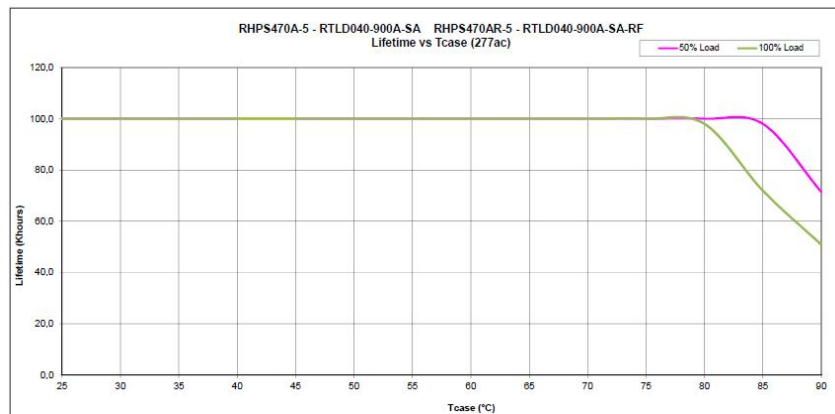

**RTLD040-0900A 277 V<sub>AC</sub> Full/Half load**

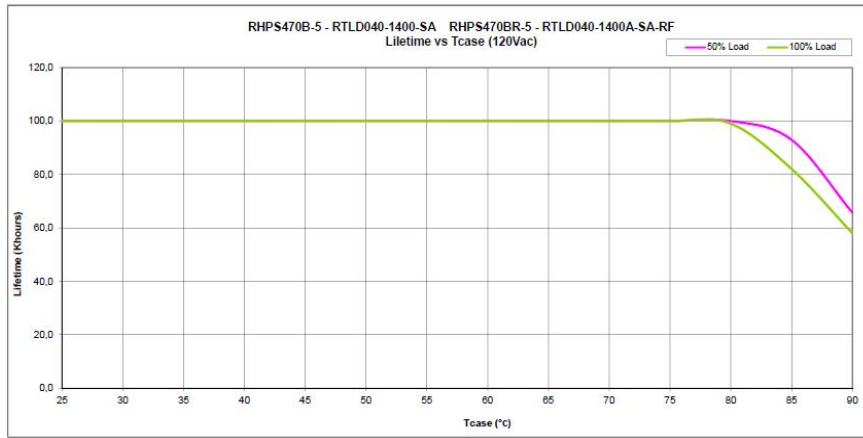

**RTLD040-1400A 120 V<sub>AC</sub> Full/Half load**

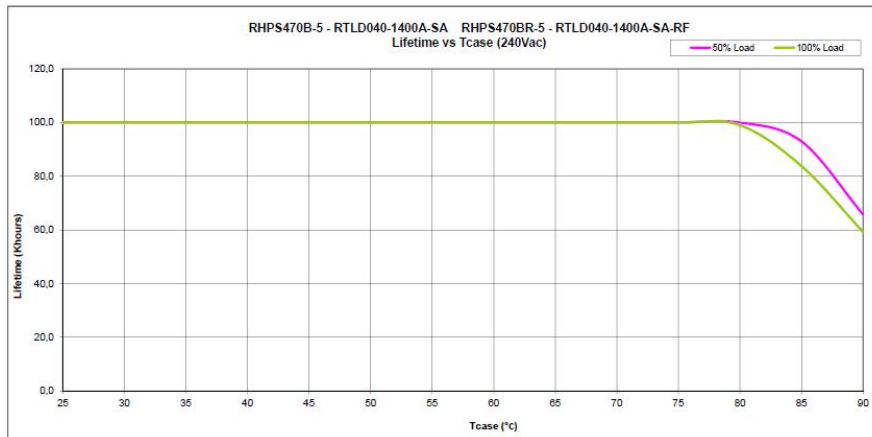

**RTLD040-1400A 230 V<sub>AC</sub> Full/Half load**

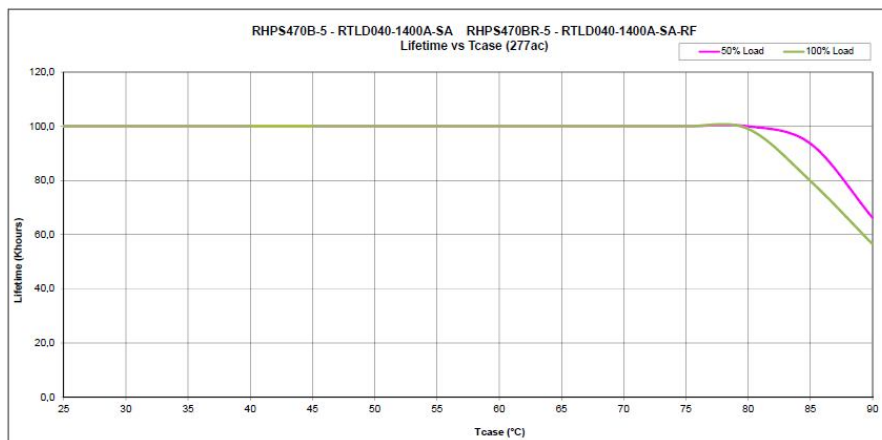

**RTLD040-1400A 277 V<sub>AC</sub> Full/Half load**



## PROGRAMMABILITY

Strato EVO 40W provides 2 methods to program the output characteristics; wireless and wired. Similar features can be programmed through each method.

**Wireless:** RFID technology is used to enable true wireless programming of the features without the need to energize or connect the driver to test equipment. A compatible RFID reader and ENEDO software is required. Two pad reader options are available. A single driver pad reader is handheld and suitable to program individual drivers. The multiple driver pad reader will program a box of Strato EVO 40W LED Drivers simultaneously, without opening the box.



**Single driver pad reader**  
Ordering Code:  
**ROALSET-Single**



Care must be paid to place the driver on the reader black transmitting surface, as shown in the picture above, so to ensure a driver reliable and successful programming.



**Multiple driver pad reader**  
Ordering Code:  
**ROALSET-Multi**



For multiple and simultaneous LED drivers programming operation, place the carton box on the dedicate tray as shown in the picture above so to ensure all the driver contained in the box a reliable and successful programming.

**Wired:** All models can also be programmed with the Ozone Programming Tool (**RSOZ070-PTOOL**) for backward compatibility.



**Ozone Programming Tool**  
Order Code: **RSOZ070-PTOOL**



## OZONE PROGRAMMING TOOL (AVAILABLE AS OPTIONAL)

Strato EVO 40W can be easily set by the customer, for this reason they are extremely flexible and suitable for several applications. For this purpose, an external module (Ozone Programming Tool) is available as optional and can be ordered separately specifying its Ordering Code<sup>2</sup>.

This external module is designed to be connected to the Strato EVO LED Driver output. The Programming Tool is powered by a long-life battery; it is safe and easy to use; therefore, no particular technical skills are required to set the product.

The Ozone Programming Tool allows you to set the output current value (Current Setting) and to enable other functionalities (Fade Time Setting, NTC Value 10 kΩ or 100kΩ).

<sup>2</sup> The Ordering Code for the Ozone Programming Tool is **RSOZ070-PTOOL**. The 3-wire programming cable represented in the figure and a USB cable (for PC connection) are included with the Tool.

## PROGRAMMING TOOL CONNECTION

The Ozone Programming Tool is easily connectable with Strato EVO LED Driver by the 3-wire cable provided together with the tool.

The programming wires are identified by colored collars placed near the metal end terminals.

Follow the connection table below for a correct programming connections correspondence between programming wires and Strato EVO outputs.



STRATO EVO Connection		Programming Wire	
Ts	Orange		RED collar wire
-DIM	Grey		BLACK wire
+DIM	Purple		WHITE collar wire

Table 2: Programming Tool Connection



## MECHANICAL DIMENSIONS AND BATTERY REPLACEMENT

### Ozone Programming Tool **RSOZ070-PTOOL**:

Dimensions: 80 x 55 x 19 mm (3.15 x 2.16 x 0.75 in)

Weight: 75 gr (2.64 oz)

3-wire Programming Cable length 750 mm (29.5 in)

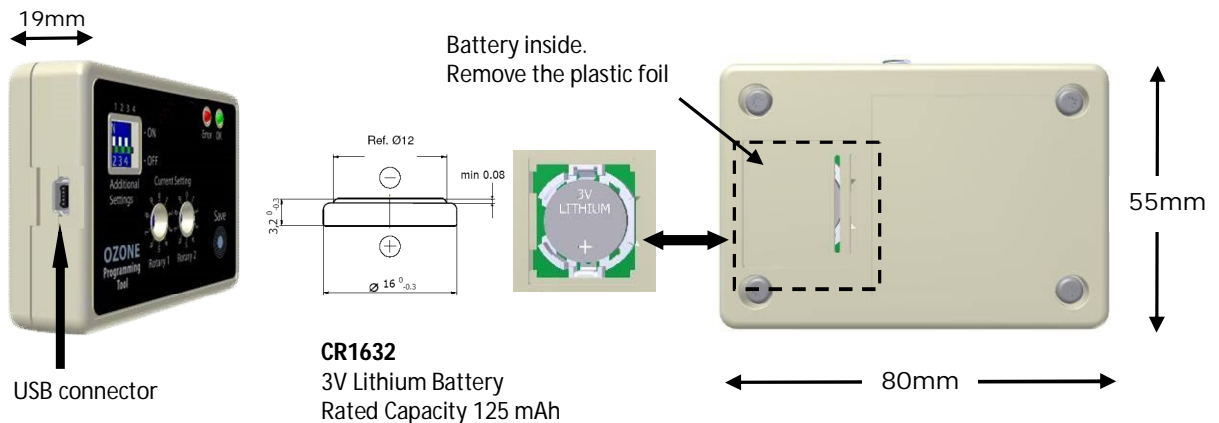

## CURRENT SETTING

The Current value can be easy set also by the customer using the Ozone Programming Tool, by moving 2 rotary switches (R1= Rotary 1, R2=Rotary 2), 10 positions each. The Table below shows the current set values ( $I_{SET}$ ) and the LED Driver Output Voltage Range, according to the positions of the Rotary Switches.

**Table 3:** Rotary Switch settings combinations RTL040-900A-SA-RF

$I_{SET}$ mA	Rotary R1 - R2	$V_{OUT}$ Min $V_{DC}$	$V_{OUT}$ Max $V_{DC}$	$I_{SET}$ mA	Rotary R1 - R2	$V_{OUT}$ Min $V_{DC}$	$V_{OUT}$ Max $V_{DC}$	Notes
	0-0							<p>STRATO EVO 40W is factory pre-set to the following values:</p> <p><math>I_{SET} = 900</math> mA for RTL040-900A-SA-RF</p>
	0-1			600	5-0	25	56	
	0-2			610	5-1	25	56	
	0-3			620	5-2	25	56	
	0-4			630	5-3	25	56	
				640	5-4	25	56	
150	0-5	25	56	650	5-5	25	56	
160	0-6	25	56	660	5-6	25	56	
170	0-7	25	56	670	5-7	25	56	
180	0-8	25	56	680	5-8	25	56	
190	0-9	25	56	690	5-9	25	56	
200	1-0	25	56	700	6-0	25	56	
210	1-1	25	56	710	6-1	25	55	
220	1-2	25	56	720	6-2	25	54	
230	1-3	25	56	730	6-3	25	54	
240	1-4	25	56	740	6-4	25	53	
250	1-5	25	56	750	6-5	25	52	
260	1-6	25	56	760	6-6	25	52	
270	1-7	25	56	770	6-7	25	51	
280	1-8	25	56	780	6-8	25	50	
290	1-9	25	56	790	6-9	25	50	
300	2-0	25	56	800	7-0	25	49	
310	2-1	25	56	810	7-1	25	48	
320	2-2	25	56	820	7-2	25	48	
330	2-3	25	56	830	7-3	25	47	
340	2-4	25	56	840	7-4	25	47	
350	2-5	25	56	850	7-5	25	46	
360	2-6	25	56	860	7-6	25	46	
370	2-7	25	56	870	7-7	25	45	
380	2-8	25	56	880	7-8	25	45	
390	2-9	25	56	890	7-9	25	44	
400	3-0	25	56	900	8-0	25	43	
410	3-1	25	56		8-1			
420	3-2	25	56		8-2			
430	3-3	25	56		8-3			
440	3-4	25	56		8-4			
450	3-5	25	56		8-5			
460	3-6	25	56		8-6			
470	3-7	25	56		8-7			
480	3-8	25	56		8-8			
490	3-9	25	56		8-9			
500	4-0	25	56		9-0			
510	4-1	25	56		9-1			
520	4-2	25	56		9-2			
530	4-3	25	56		9-3			
540	4-4	25	56		9-4			
550	4-5	25	56		9-5			
560	4-6	25	56		9-6			
570	4-7	25	56		9-7			
580	4-8	25	56		9-8			
590	4-9	25	56		9-9			

**Table 4:** Rotary Switch settings combinations RTLD040-1400A-SA-RF

I <sub>SET</sub> mA	Rotary R1 - R2	V <sub>OUT</sub> Min V <sub>DC</sub>	V <sub>OUT</sub> Max V <sub>DC</sub>	I <sub>SET</sub> mA	Rotary R1 - R2	V <sub>OUT</sub> Min V <sub>DC</sub>	V <sub>OUT</sub> Max V <sub>DC</sub>	Notes
	0-0			<b>600</b>	5-0	20	43	STRATO EVO 40W is factory pre-set to the following values:  I <sub>SET</sub> = 1400 mA for RTLD040-1400A-SA-RF
	0-1			610	5-1	20	43	
	0-2			620	5-2	20	43	
	0-3			630	5-3	20	43	
	0-4			640	5-4	20	43	
	0-5			<b>650</b>	5-5	20	43	
	0-6			660	5-6	20	43	
	0-7			670	5-7	20	43	
	0-8			680	5-8	20	43	
	0-9			690	5-9	20	43	
<b>200</b>	1-0	20	43	<b>700</b>	6-0	20	43	
210	1-1	20	43	710	6-1	20	43	
220	1-2	20	43	720	6-2	20	43	
230	1-3	20	43	730	6-3	20	43	
240	1-4	20	43	740	6-4	20	43	
<b>250</b>	1-5	20	43	<b>750</b>	6-5	20	43	
260	1-6	20	43	760	6-6	20	43	
270	1-7	20	43	770	6-7	20	43	
280	1-8	20	43	780	6-8	20	43	
290	1-9	20	43	790	6-9	20	43	
<b>300</b>	2-0	20	43	<b>800</b>	7-0	20	43	
310	2-1	20	43	810	7-1	20	43	
320	2-2	20	43	820	7-2	20	43	
330	2-3	20	43	830	7-3	20	43	
340	2-4	20	43	840	7-4	20	43	
<b>350</b>	2-5	20	43	<b>850</b>	7-5	20	43	
360	2-6	20	43	860	7-6	20	43	
370	2-7	20	43	870	7-7	20	43	
380	2-8	20	43	880	7-8	20	43	
390	2-9	20	43	890	7-9	20	43	
<b>400</b>	3-0	20	43	<b>900</b>	8-0	20	43	
410	3-1	20	43	910	8-1	20	43	
420	3-2	20	43	920	8-2	20	42	
430	3-3	20	43	930	8-3	20	42	
440	3-4	20	43	940	8-4	20	41	
<b>450</b>	3-5	20	43	<b>950</b>	8-5	20	41	
460	3-6	20	43	960	8-6	20	40	
470	3-7	20	43	970	8-7	20	40	
480	3-8	20	43	980	8-8	20	40	
490	3-9	20	43	990	8-9	20	39	
<b>500</b>	4-0	20	43	<b>1000</b>	9-0	20	39	
510	4-1	20	43	1050	9-1	20	37	
520	4-2	20	43	1100	9-2	20	35	
530	4-3	20	43	1150	9-3	20	34	
540	4-4	20	43	1200	9-4	20	32	
<b>550</b>	4-5	20	43	1250	9-5	20	31	
560	4-6	20	43	1300	9-6	20	30	
570	4-7	20	43	1350	9-7	20	29	
580	4-8	20	43	<b>1400</b>	<b>9-8</b>	<b>20</b>	<b>28</b>	
590	4-9	20	43		9-9			

## DIP-SWITCH SETTINGS (FADING TIME AND DIMMING SETTINGS)

The 4-position dip-switch on the remote programming tool permits to set the light fade time and the analog dimming option.

Follow the dip-switch settings combination table (**Table 5**) below to select the requested configuration. Each switch can stand in ON or OFF position, the combination of the four switches positions determines the product configuration as reported in the table.

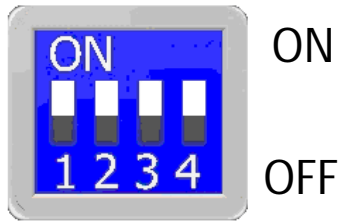

Sw. 1	Sw. 2	Fade time (s)
OFF	OFF	0
ON	OFF	2
OFF	ON	5
ON	ON	10

Sw. 3	Dimming Option
OFF	1-10V
ON	0-10V (DTO)

Sw. 4	NTC option
OFF	100k NTC
ON	10k NTC

Red = factory pre-set values

**Table 5:** Dip-switch settings combinations

**Fade Time:** Required time (in seconds) to raise linearly the output LED current from 0 A (OFF state) to the nominal set current ( $I_{SET}$ ) and vice versa. Fade Time will also affect the 0-10 V linear dimming function.

**Dimming option:** This parameter set the driver response to a dimmer voltage less than 1 V. When selected 1-10 V and the dimmer voltage is less than 1 V the output current of the driver will be 1 % of the  $I_{max}$ . When selected 0-10 V and the dimmer voltage is less than 1 V the current on the LED will be forced to zero.

**NTC option:** This parameter set the driver response to two different NTC types 100 k $\Omega$  or 10 k $\Omega$

## PROGRAMMING OPERATIONS SEQUENCE

Run the following 10-step sequence for programming the LED Driver, using the “RSOZ070-PTOOL” external Programming Tool.

1. If connected, unplug AC power from the LED Driver input AC wires.
2. If connected, unplug all wires from the secondary side (LED board, Ts, Dimming).
3. Connect the 3-wire cable of the external Programming Tool to the LED Driver output sections as described in the “Programming Tool connection” section.
4. Reconnect the AC power to the LED Driver input AC side.
5. Select and run the correct Dip-switch settings combinations according to **Table 5**.
6. Choose the output Constant Current value and place the correspondent rotary switches positions (see **Table 3** or **Table 4**).
7. Press “Save” push button.
8. Verify the feedback green LED blinks (2 fast blinks followed by 1 longer blink).
9. Verify that the error red LED remains OFF after the green LED blinking.
10. First disconnect the AC cable and then the 3-wire programming cable from the LED Driver output section.

Now the new settings are installed and they will be active at the next LED Driver power-on.

**WARNINGS:** If the error red LED turns-on after the two green LED fast blinks, it means that the programming operation failed. In this case, repeat the programming sequence from the beginning paying particular attention to wires connections and rotary switches combination.

Any rotary switches combination not shown in **Table 3** or **Table 4** must be considered as not allowed.

**Note:** Additional red LED fast blinks after the programming phase, indicate a low battery level.

## MECHANICAL DETAILS

<b>Packaging:</b>	Polycarbonate (PC), UL94 V-0
<b>Color:</b>	Black RAL 9005
<b>I/O Connections:</b>	Flying leads
<b>Input wires:</b>	n°2 wires 18 AWG 200 °C rated (L/N), double insulation wire (Black/White), stranded, 152 mm long
<b>Output wires:</b>	n°2 wires 18 AWG 105 °C rated (LED+/LED-), stranded, 152 mm long
<b>Control wires:</b>	n°3 wires 22 AWG 105 °C rated (+DIM/-DIM/Ts), stranded, 152 mm long All wires are stripped by approximately 9.5mm and tinned.
<b>Ingress Protection:</b>	IP64
<b>Mounting Details:</b>	2 mounting locations

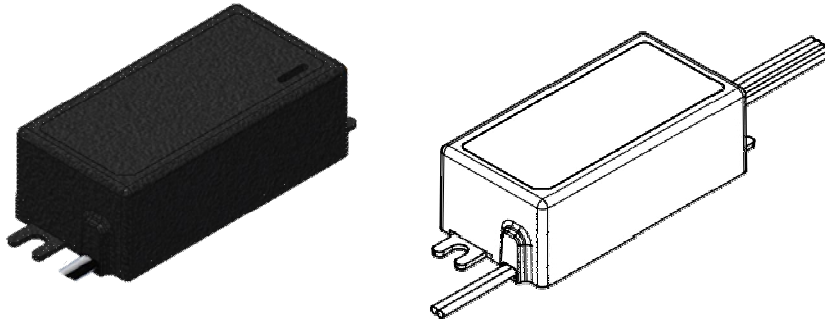

## OUTLINE DRAWINGS

<b>Package:</b>	RTL040	<b>Box:</b>	Carton Box
<b>Dimensions:</b>	78 x 40 x 27 mm (3.07 x 1.57 x 1.06 in)	<b>Dimensions:</b>	32 x 26 x 7.5 cm (12.6 x 10.2 x 2.9 in)
<b>Volume:</b>	84.2 cm <sup>3</sup> (5.1 in <sup>3</sup> )	<b>Units per Box:</b>	20 pcs
<b>Mass:</b>	170 g (6.0 oz)	<b>Mass:</b>	3.8 kg (83.77 lb)

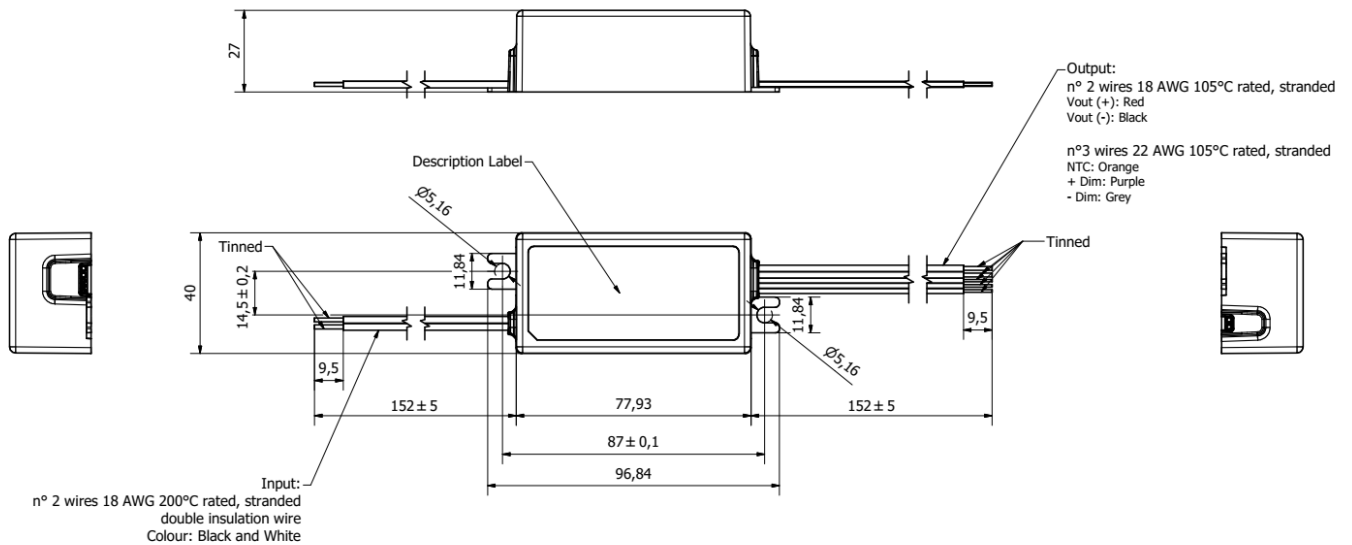
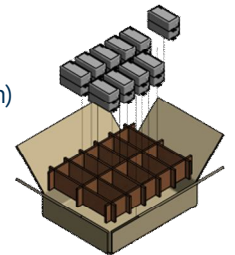

## ENVIRONMENTAL SPECIFICATIONS

Specification	Test Conditions / Notes	Min	Nom	Max	Units
Reference Case Temp. ( $T_c$ )	Top case temperature without derating	-30	-	90	°C
Ambient Temperature	$T_c$ temperature is within the limit (90°C). See $P_{OUT} - T_{AMB}$ correlation below	-30	-	60	°C
Storage Temperature	Relative Humidity 95% non-condensing	-30	-	90	°C
Operating Relative Humidity	Non-condensing	5	-	95	%
Surface Temperature	Exposed surfaces temperature under all operating conditions	-	-	90	°C
Cooling	Convection cooled				
Shock EN 60068-2-27	Operating: Half sine 30g/18ms, 3 axes, 6x each (3 positive and 3 negative) Non-Operating: Half sine, 50g/11ms, 3 axes, 6x each (3 positive and 3 negative)				
Vibration EN 60068-2-64	Operating: 5-500Hz, 1gRMS (0.02 g <sup>2</sup> /Hz), 3 axes, 30 min Non-Operating: 5-500Hz, 2.46gRMS (0.0122 g <sup>2</sup> /Hz), 3 axes, 30 min				
Vibration EN 60068-2-6	Operating Sine, 10-500Hz, 1g, 3 axes, 1 Oct/min., 60 min				
MTBF	MAX Load, 40 °C Ambient, Telcordia SR-332 Issue 2, 80% duty cycle	-	500k	-	Hours
Useful Life	Nominal 40 °C Typical Nominal $V_{AC}$ , 75 °C $T_c$ , 80 % of rated load	-	100k	-	Hours

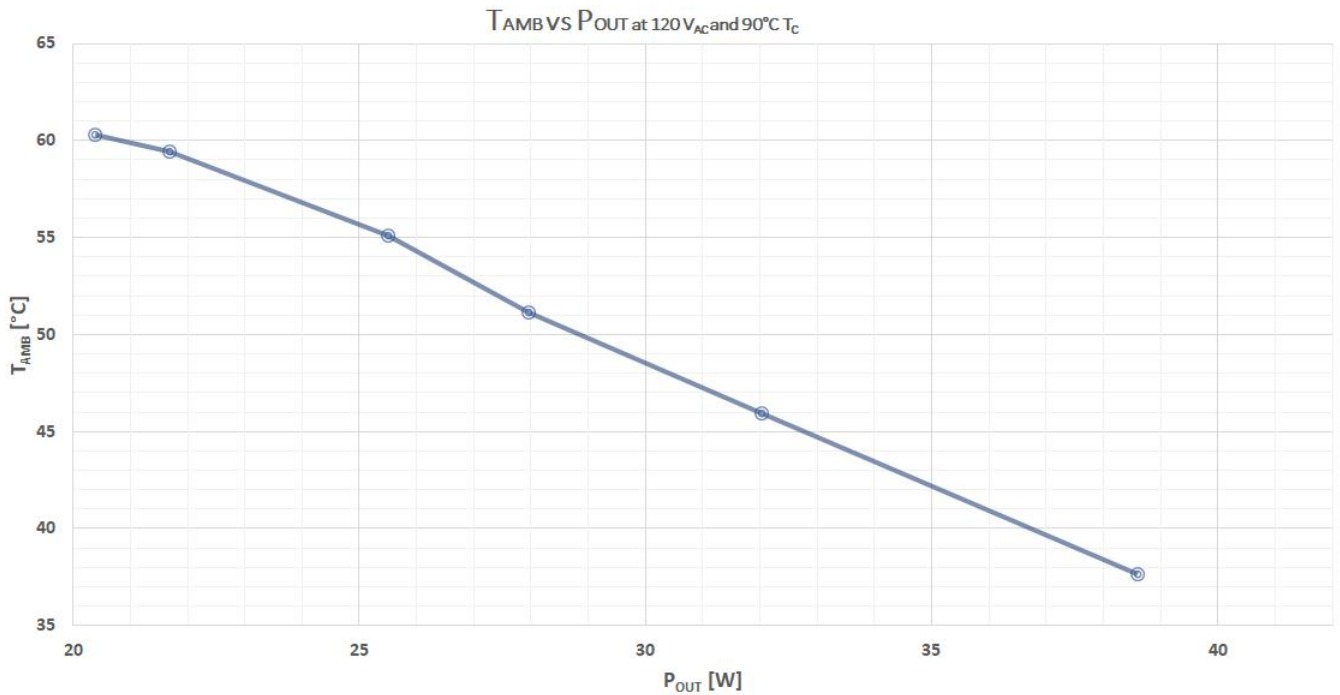

## ELECTROMAGNETIC COMPATIBILITY (EMC) – EMISSIONS

Phenomenon	Conditions / Notes	Standard	Performance Class
Conducted Emission	Test at 120 $V_{AC}$	FCC CFR47- part 15 / Subpart B	Class B
	Test at 230 $V_{AC}$	EN55015	-
	Test at 277 $V_{AC}$	FCC CFR47- part 15 / Subpart B	Class A
Radiated Emission	Test at 120 $V_{AC}$	FCC CFR47- part 15 / Subpart B	Class B
	Test at 230 $V_{AC}$	EN55015	-
	Test at 277 $V_{AC}$	FCC CFR47- part 15 / Subpart B	Class A
Harmonic Current Emissions		EN61000-3-2	Class C
Voltage Changes, Fluctuation and Flicker		EN61000-3-3	

## ELECTROMAGNETIC COMPATIBILITY (EMC) – IMMUNITY

Phenomenon	Conditions / Notes	Standard	Note
Equipment for general lighting purposes - EMC Immunity Requirements		EN61547	
ESD (Electrostatic Discharge)	8kV air, 4kV contact	EN61000-4-2	
Radiated Radio-Frequency electromagnetic field		EN61000-4-3	
Electric Fast Transient / Burst	Level $\pm 1.0$ kV L-L	EN61000-4-4	
Surge	Level $\pm 2.0$ kV L-L	EN61000-4-5	
Conducted disturbances induced by Radio-Frequency fields		EN61000-4-6	
Power Frequency Magnetic Field Test		EN61000-4-8	
Voltage Dips, short interruptions and Voltage Variations		EN61000-4-11	
Non-repetitive damped oscillatory transient, Ring wave	2.5kV	ANSI C.62.41	Category A1

## SAFETY AGENCY APPROVALS

Certification Body	Safety Standards
	UL Recognized ANSI/UL 8750, CSA C22.2 No. 250.13 Models with output voltages $< 60 V_{DC}$ include UL and CSA approval (cUR <sub>US</sub> ) as Class 2 output LED Driver suitable for dry and damp location
	IEC/EN 62384 Electronic control gear for LED modules – Performance Requirements IEC/EN, 61347-1, IEC/EN 61347-2-13 Electronic control gear for LED Modules – Safety
	Directive 2014/35/EU (Electrical Safety: low-voltage electrical equipment- LVD) Directive 2014/30/EU (Electromagnetic Compatibility - EMC) Directive 2009/125/EC (Eco-Design) Commission Regulation(EU) No.1194/2012 Directive 2011/65/EU, 2015/863/EU (RoHS 3) To obtain the “CE Declaration of Conformity” please contact <a href="mailto:info@enedopower.com">info@enedopower.com</a>
	IECEE CB Certified, IEC/EN, 61347-1, IEC/EN 61347-2-13 electronic control gear for LED Modules All models are isolated control gears, SELV equivalent, with internal reinforced insulation as per IEC/EN 61347-2-13 Drivers to be incorporated in the luminaire
	GB19510.1-2009, GB19510.14-2009, GB17625.1-2012, GB/T17743-2007
	Reinforced/double Insulation meets IEC/EN61347-2-13

Specifications appearing in ENEDO's catalogues and brochures as well as any oral statements are not binding. All descriptions, drawings and other particulars (including dimensions, materials and performance data) given by ENEDO are as accurate as possible but, being given for general information, and are not binding on ENEDO. ENEDO makes thus no representation or warranty as to the accuracy of such material. We assume no liability other than as agreed in the terms of the individual contracts and we reserve the right to make technical modifications in the course of our product development. Our product information solely describes our goods and services and is in no way to be construed or interpreted as a quality or condition guarantee. The aforesaid shall not relieve the customer of its obligation to verify the suitability of our Products for the use or application intended by the purchaser. Customers are responsible for their products and applications. ENEDO assumes no liability from the use of its products outside of specifications. No license is granted to any intellectual property rights by this document.